

LICO

The lightweight column formwork
for forming by hand



PERI LICO

Crane-independent, flexible, inexpensive

LICO, the lightweight column formwork for cost-effective forming also without a crane.

The low individual weights of the elements allow assembly and dismantling by hand. This means that the formwork crew is still in a position to effectively use crane non-availability in a productive way.

Practical details simplify the use and lower shuttering times.

The high permissible fresh concrete pressure of 80 kN/m² ensures fast concreting cycles and thus contributes to a very economical utilisation of the equipment.

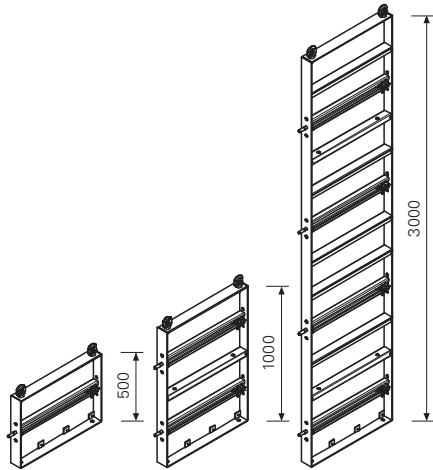

Height increments 500 mm

Only three different element heights: 3.00 m, 1.00 m and 0.50 m. These allow optimal adjustment to the required concreting heights.



Column cross-sections

Different cross-section combinations permit rectangular or square configurations from 200 x 200 to 600 x 600 mm in 50 mm increments.

3.00 m high LICO column formwork with RSS I Push-Pull Props for construction of an office building.



Captive column tie bolts and nuts are permanently attached to each element.



Eye bolt as load bearing point for moving as well as easy and simple extensions.

LICO chamfer strip, Item no. 111975, is simply attached to the front side of the element.

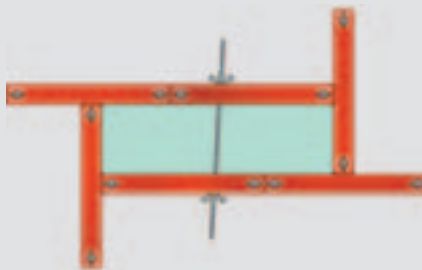

Column cross-sections from 200 x 200 mm to 600 x 600 mm can be realised both square or rectangular-shaped in 50 mm increments.

With centrally-positioned ties, cross-sections up to 60 x 130 mm can be formed. Element connections are carried out using standard M20 bolts.



Practice-oriented details

- The LICO captive column tie bolts and nuts are permanently attached to the elements.
- Eye bolts on all elements serve as load bearing points for moving with the crane as well as for element connections when extending.
- The chamfer strips are easily fitted on the elements – this saves time-consuming and cost-intensive nailing of conventional strips.

Item no.	Weight kg
111683	74.700

Column Panel LICO 700 x 3000

Column panels for cross-sections from 20 x 20 cm up to 60 x 60 cm in 5 cm increments. 12 mm Fin-Ply formlining.

Complete with

- 4 pc. 111679 Column Tie Nut LICO DW 15
- 4 pc. 111682 Column Tie Bolt LICO DW 15
- 2 pc. 710130 Loop Bolt M20 x 40, galv.
- 2 pc. 781053 Nut ISO 7042 M20-8, galv.
- 48 pc. 030290 Plug Ø 20 mm

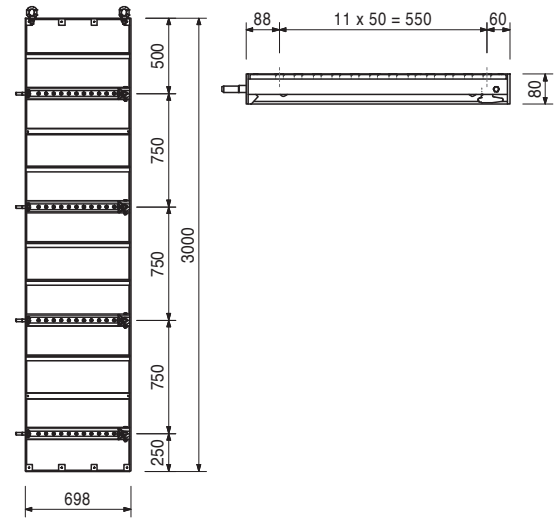

111957	32.600
--------	--------

Column Panel LICO 700 x 1000

Column panels for cross-sections from 20 x 20 cm up to 60 x 60 cm in 5 cm increments. 12 mm Fin-Ply formlining.

Complete with

- 2 pc. 111679 Column Tie Nut LICO DW 15
- 2 pc. 111682 Column Tie Bolt LICO DW 15
- 2 pc. 710130 Loop Bolt M20 x 40, galv.
- 2 pc. 781053 Nut ISO 7042 M20-8, galv.
- 24 pc. 030290 Plug Ø 20 mm

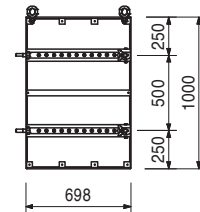
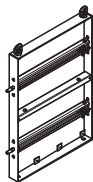

111964	17.000
--------	--------

Column Panel LICO 700 x 500

Column panels for cross-sections from 20 x 20 cm up to 60 x 60 cm in 5 cm increments. 12 mm Fin-Ply formlining.

Complete with

- 1 pc. 111679 Column Tie Nut LICO DW 15
- 1 pc. 111682 Column Tie Bolt LICO DW 15
- 2 pc. 710130 Loop Bolt M20 x 40, galv.
- 2 pc. 781053 Nut ISO 7042 M20-8, galv.
- 12 pc. 030290 Plug Ø 20 mm

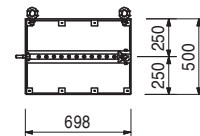
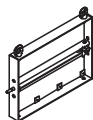

Item no.	Weight kg
111975	1.080

Chamfer Strip LICO I = 3.00 m
For attaching to the LICO column panels.

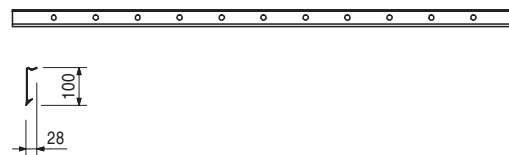
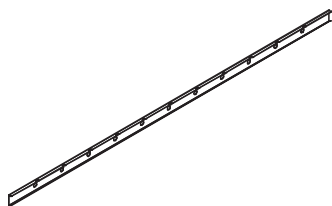

037530	1.130
--------	-------

Brace Connector QUATTRO QR
For connecting push-pull props and kicker braces to QUATTRO and LICO panels.

Complete with
1 pc. 027170 Pin \varnothing 16 x 42, galv.
1 pc. 018060 Cotter Pin 4/1, galv.

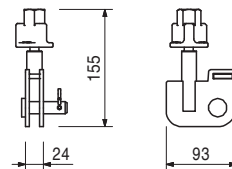

115019	0.334
--------	-------

Lifting Pin LICO

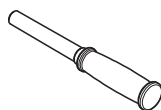

030290	0.002
--------	-------

Plug \varnothing 20 mm
For closing \varnothing 20 mm tie holes which are not required.

Note
Delivery unit 500 pieces.

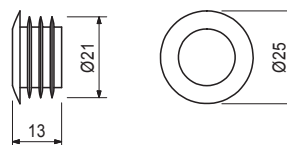

124739	0.003
--------	-------

Plug \varnothing 20 mm LICO
For closing \varnothing 20 mm tie holes which are not required.

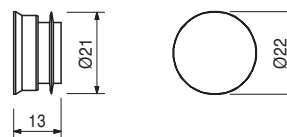

LICO Column Formwork



Item no.	Weight kg
116432	0.957

Spanner LICO
For tying LICO column formwork.

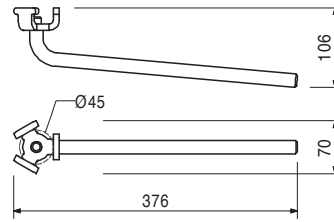
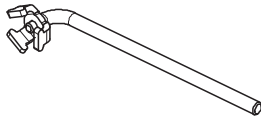

115894	22.900
--------	--------

Concreting Platform LICO
Working and concreting platform for LICO column formwork.

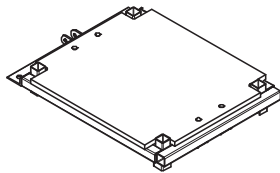

Technical Data
Permissible load 150 kg/m².

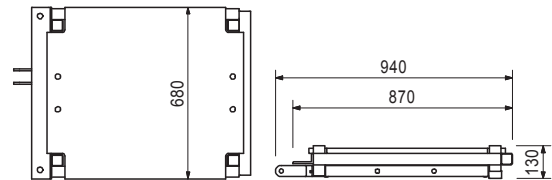

116292	4.730
--------	-------

Accessories
Guardrail Post HSGP-2

115895	17.600
--------	--------

Concreting Platform LICO Frame
Working and concreting platform for LICO column formwork. Decking by customer.

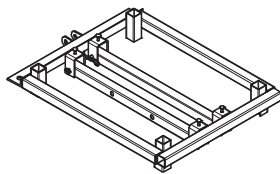

Technical Data
Permissible load 150 kg/m².

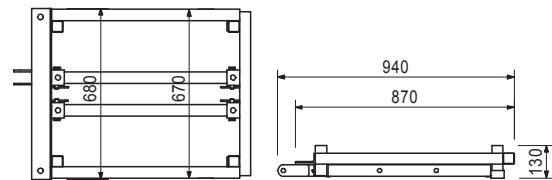

115896	5.270
--------	-------

Concreting Platform LICO Cover
As replacement cover for Concreting Platform LICO.

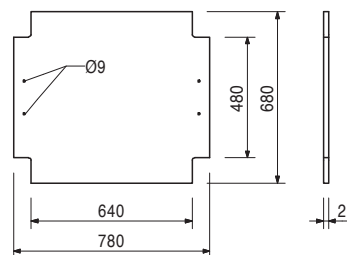
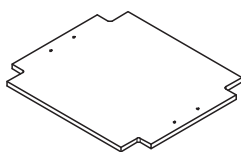

Item no.	Weight kg
116292	4.730

Guardrail Post HSGP-2
As guardrail for different systems.

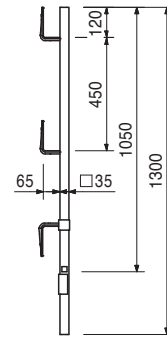

114620	0.026
--------	-------

Stacking Aid LICO
For easy stacking of LICO panels.

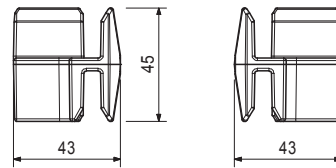
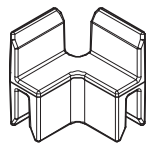

034630	0.008
--------	-------

Stacking Device-2 LICO

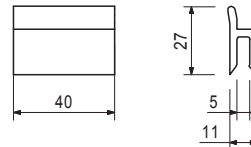
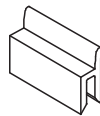

117466	10.600
--------	--------

Push-Pull Prop RS 210, galv.
Extension length $l = 1.30 - 2.10$ m.
For aligning PERI formwork systems and precast concrete elements.

Note
Permissible load see PERI Design Tables.

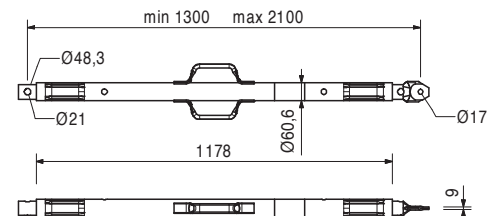
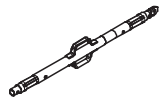

LICO Column Formwork



Item no.	Weight kg
118238	12.200

Push-Pull Prop RS 260, galv.

Extension length $l = 2.30 - 2.60$ m.
For aligning PERI formwork systems and precast concrete elements.

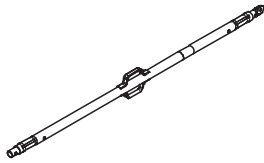

Note

Permissible load see PERI Design Tables.

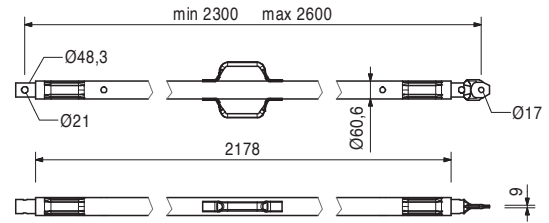

117467	15.500
--------	--------

Push-Pull Prop RS 300, galv.

Extension length $l = 1.90 - 3.00$ m.
For aligning PERI formwork systems and precast concrete elements.

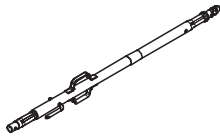

Note

Permissible load see PERI Design Tables.

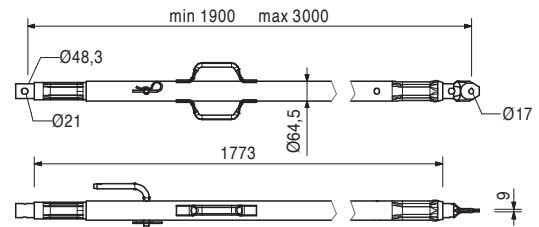

117468	23.000
--------	--------

Push-Pull Prop RS 450, galv.

Extension length $l = 2.80 - 4.50$ m.
For aligning PERI formwork systems and precast concrete elements.

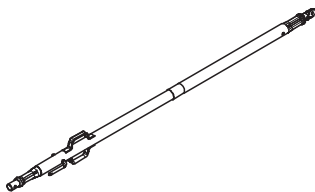

Note

Permissible load see PERI Design Tables.

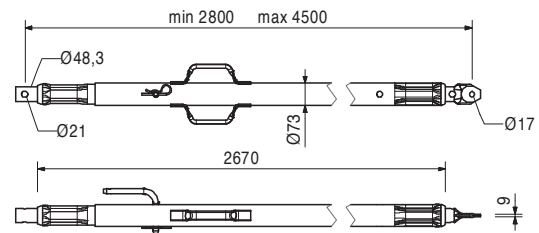

117469	40.000
--------	--------

Push-Pull Prop RS 650, galv.

Extension length $l = 4.30 - 6.50$ m.
For aligning PERI formwork systems and precast concrete elements.

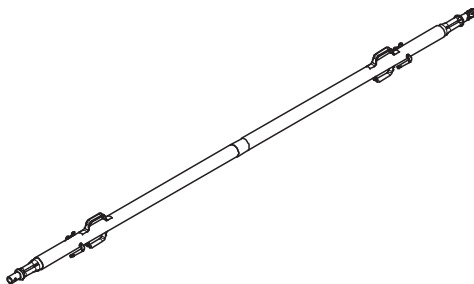

Note

Permissible load see PERI Design Tables.

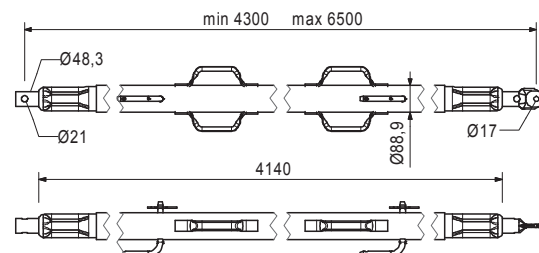

LICO Column Formwork



Item no.	Weight kg
028990	115.000

Push-Pull Prop RS 1000, galv.
 Extension length $l = 6.40 - 10.00$ m.
 For aligning PERI formwork systems.

Note
 Permissible load see PERI Design Tables.

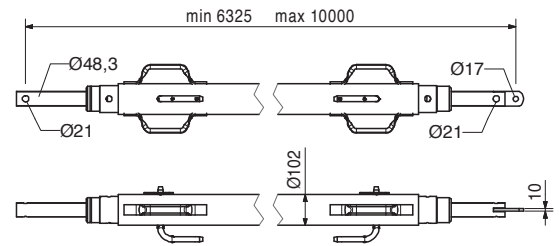
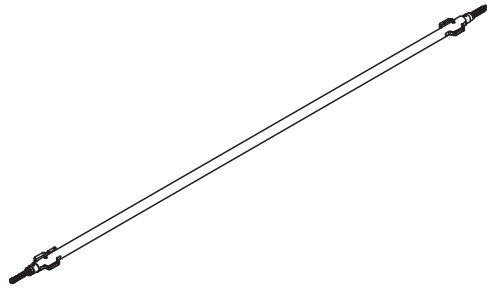

103800	271.000
--------	---------

Push-Pull Prop RS 1400, galv.
 Extension length $l = 6.40 - 14.00$ m.
 For aligning PERI formwork systems.

Note
 Permissible load see PERI Design Tables.
 Chain can be operated from bottom.

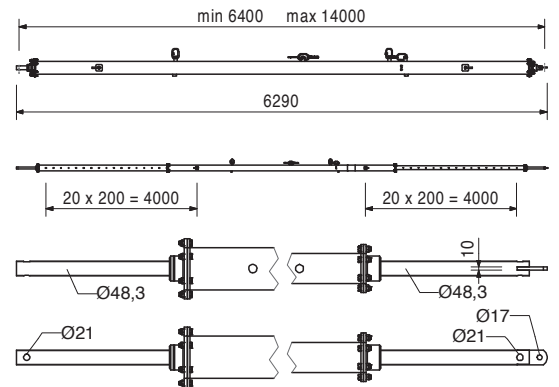
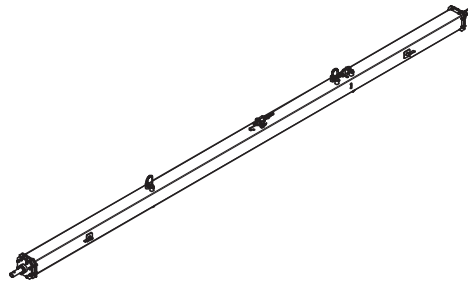

117343	3.250
--------	-------

Base Plate-2 for RS 210 – 1400, galv.
 For assembly of Push-Pull Props RS 210, 260, 300, 450, 650, 1000 and 1400.

Complete with
 2 pc. 105400 Pin Ø 20 x 140, galv.
 2 pc. 018060 Cotter Pin 4/1, galv.

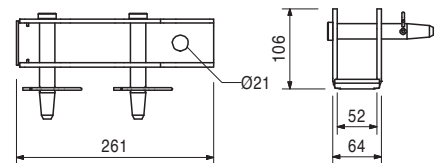
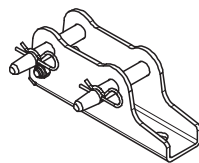

124777	0.210
--------	-------

Accessories
Anchor Bolt PERI 14/20 x 130

Item no.	Weight kg
126666	3.070

Base Plate-3 for RS 210-1400

For assembly of Push-Pull Props RS 210, 260, 300, 450, 650, 1000 and 1400.

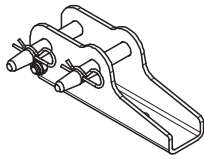

Complete with

- 2 pc. 105400 Pin \varnothing 20 x 140, galv.
- 2 pc. 018060 Cotter Pin 4/1, galv.
- 1 pc. 113063 Bolt ISO 4014 M12 x 80-8.8, galv.

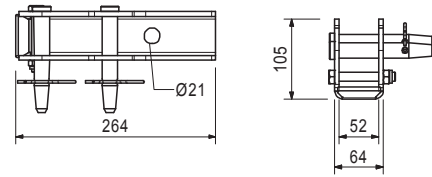

028010	17.900
--------	--------

Push-Pull Prop RSS I

Extension length $l = 2.05 - 2.94$ m.
For aligning PERI formwork systems.

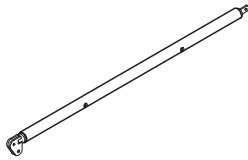

Note

Permissible load see PERI Design Tables.

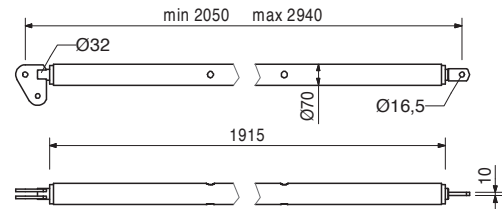

113397	1.600
--------	-------

Spindle Handle RSS / AV

Spindle Handle for screwing on Push-Pull-Props RSS I, RSS II, RSS III and Kickers AV 210 and AV 190 complete with 2 bolts and nuts M8.

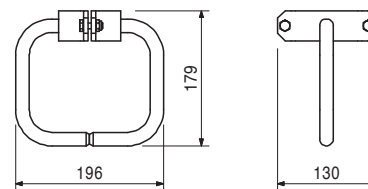
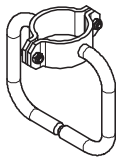

028020	22.000
--------	--------

Push-Pull Prop RSS II

Extension length $l = 2.91 - 3.80$ m.
For aligning PERI formwork systems.

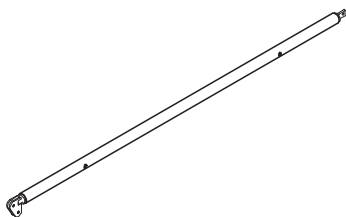

Note

Permissible load see PERI Design Tables.

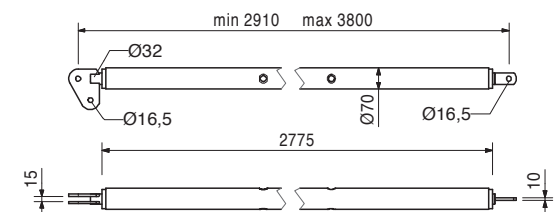

Item no.	Weight kg
028030	38.400

Push-Pull Prop RSS III
 Extension length l = 4.60 – 6.00 m.
 For aligning PERI formwork systems.

Note
 Permissible load see PERI Design Tables.

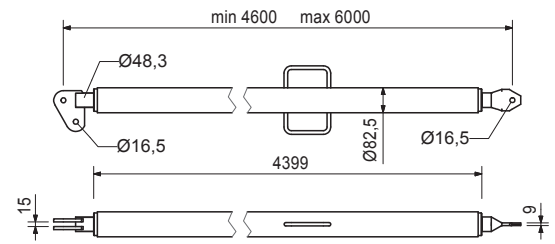
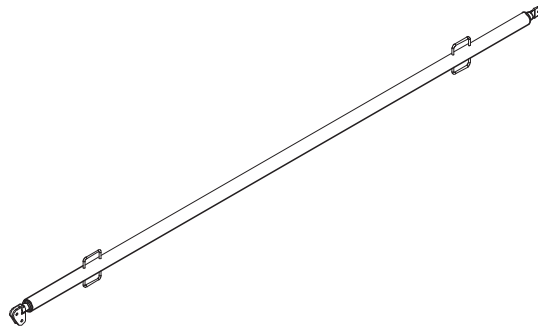

106000	1.820
--------	-------

Base Plate-2 for RSS, galv.
 For assembly of RSS Push-Pull Props.

Complete with
 1 pc. 027170 Pin Ø 16 x 42, galv.
 1 pc. 018060 Cotter Pin 4/1, galv.

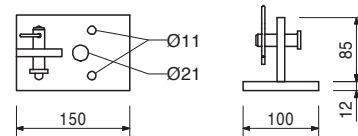
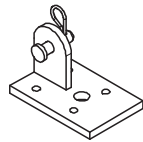

Accessories
Anchor Bolt PERI 14/20 x 130

124777	0.210
--------	-------

057087	3.720
057088	4.410

Kickers AV
Kicker AV 82
Kicker AV 111
 For aligning PERI formwork systems.

min. L	max. L
500	820
790	1110

Complete with
 1 pc. 027170 Pin Ø 16 x 42, galv.
 1 pc. 018060 Cotter Pin 4/1, galv.

Note
 Permissible load see PERI Design Tables.

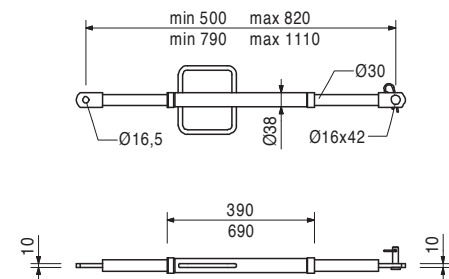
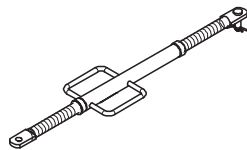

LICO Column Formwork



Item no.	Weight kg
028110	5.180

Kicker AV 140
 Extension length $l = 1.08 - 1.40$ m.
 For aligning PERI formwork systems.

Complete with
 1 pc. 027170 Pin $\varnothing 16 \times 42$, galv.
 1 pc. 018060 Cotter Pin 4/1, galv.

Note
 Permissible load see PERI Design Tables.

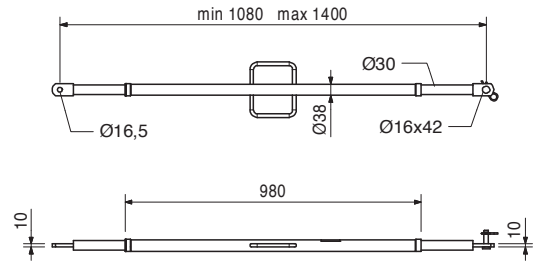
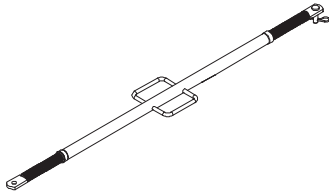

108135	12.900
--------	--------

Kicker AV 210
 Extension length $l = 1.28 - 2.10$ m.
 For aligning PERI formwork systems.

Complete with
 1 pc. 027170 Pin $\varnothing 16 \times 42$, galv.
 1 pc. 018060 Cotter Pin 4/1, galv.

Note
 Permissible load see PERI Design Tables.

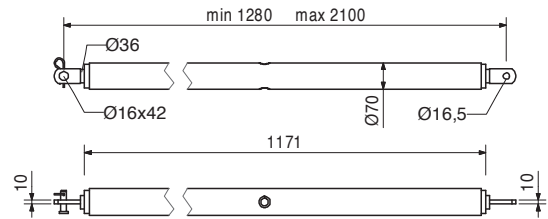
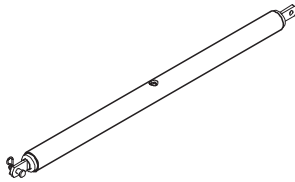

028120	17.000
--------	--------

Kicker AV RSS III
 Extension length $l = 2.03 - 2.92$ m.
 For aligning PERI formwork systems.

Complete with
 1 pc. 027170 Pin $\varnothing 16 \times 42$, galv.
 1 pc. 018060 Cotter Pin 4/1, galv.

Note
 Permissible load see PERI Design Tables.

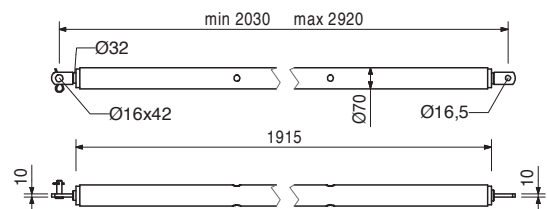
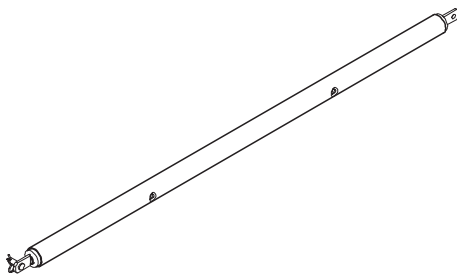

Item no.	Weight kg
124777	0.210

Anchor Bolt PERI 14/20 x 130

For temporary fixation to reinforced concrete structures.

Note

See PERI data sheet!
Drilling \varnothing 14 mm.

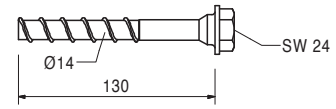
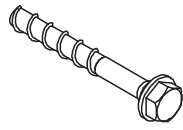

PERI International

01 Germany
PERI GmbH
 Rudolf-Diesel-Strasse 19
 89264 Weissenhorn
 info@peri.com
 www.peri.com



02 France
 PERI S.A.S.
 77109 Meaux Cedex
 peri.sas@peri.fr
 www.peri.fr

03 Switzerland
 PERI AG
 8472 Ohringen
 info@peri.ch
 www.peri.ch

04 Spain
 PERI S.A.U.
 28110 Algete - Madrid
 info@peri.es
 www.peri.es

05 Belgium/Luxembourg
 N.V. PERI S.A.
 1840 Londerzeel
 info@peri.be
 www.peri.be

06 Netherlands
 PERI Holding B.V.
 5480 AH-Schijndel
 info@peri.nl
 www.peri.nl

07 USA
 PERI Formwork Systems, Inc.
 Elkridge, MD 21075
 info@peri-usa.com
 www.peri-usa.com

08 Indonesia
 PT Beton Perkasa Wijaksana
 Jakarta 10210
 bpw@betonperkasa.com
 www.peri.com

09 Italy
 PERI S.p.A.
 20060 Basiano
 info@peri.it
 www.peri.it

10 Japan
 PERI Japan K.K.
 Tokyo 103-0015
 info@perijapan.jp
 www.perijapan.jp

11 United Kingdom/Ireland
 PERI Ltd.
 Rugby, CV23 0AN
 info@peri.ltd.uk
 www.peri.ltd.uk

12 Turkey
 PERI Kalip ve Iskeleleri Sanayi
 ve Ticaret Ltd.
 Esenyurt / Istanbul 34510
 info@peri.com.tr
 www.peri.com.tr

13 Hungary
 PERI Kft.
 1181 Budapest
 info@peri.hu
 www.peri.hu

14 Malaysia
 PERI Formwork Malaysia Sdn. Bhd.
 43300 Seri Kembangan,
 Selangor Darul Ehsan
 info@perimalaysia.com
 www.perimalaysia.com

15 Singapore
 PERI Asia Pte Ltd
 Singapore 387355
 pha@periasia.com
 www.periasia.com

16 Austria
 PERI Ges.mbh
 3134 Nußdorf ob der Traisen
 office@peri.at
 www.peri.at

17 Czech Republic
 PERI spol. S r.o.
 252 42 Jesenice u Prahy
 info@peri.cz
 www.peri.cz

18 Denmark
 PERI Danmark A/S
 2670 Greve
 peri@peri.dk
 www.peri.dk

19 Finland
 PERI Formasi Ltd. Oy
 05460 Hyvinkää
 info@perisuomi.fi
 www.perisuomi.fi

20 Norway
 PERI Norge AS
 3036 Drammen
 info@peri.no
 www.peri.no

21 Poland
 PERI Polska Sp. z o.o.
 05-860 Plochocin
 info@peri.com.pl
 www.peri.com.pl

22 Sweden
 PERIform Sverige AB
 30262 Halmstad
 peri@periform.se
 www.periform.se

23 Korea
 PERI (Korea) Ltd.
 Seoul 06243
 info@perikorea.com
 www.perikorea.com

24 Portugal
 Pericofragens Lda.
 2790-326 Queijas
 info@peri.pt
 www.peri.pt

25 Argentina
 PERI S.A.
 B1625GPA Escobar – Bs. As.
 info@peri.com.ar
 www.peri.com.ar

26 Brazil
 PERI Formas e
 Escoramentos Ltda.
 Vargem Grande Paulista – SP
 info@peribrasil.com.br
 www.peribrasil.com.br

27 Chile
 PERI Chile Ltda.
 Colina, Santiago de Chile
 perichile@peri.cl
 www.peri.cl

28 Romania
 PERI România SRL
 077015 Balotești
 info@peri.ro
 www.peri.ro

29 Slovenia
 PERI Agency
 2000 Maribor
 peri.slo@triera.net
 www.peri.com

30 Slovakia
 PERI spol. s. r.o.
 903 01 Senec
 info@peri.sk
 www.peri.sk

31 Australia
 PERI Australia Pty. Ltd.
 Glendenning NSW 2761
 info@periaus.com.au
 www.periaus.com.au

32 Estonia
 PERI AS
 76406 Saku vald
 Harjumaa
 peri@peri.ee
 www.peri.ee

33 Greece
 PERI Hellas Solely Owned Ltd.
 194 00 Koropi
 info@perihellas.gr
 www.perihellas.gr

34 Latvia
 PERI SIA
 2118 Salaspils novads, Rigas rajons
 info@peri-latvija.lv
 www.peri-latvija.lv

35 United Arab Emirates
 PERI (L.L.C.)
 Bolton, ON – L7E 1K1
 perillc@perime.com
 www.perime.com

36 Canada
 PERI Formwork Systems, Inc.
 Bolton, ON – L7E 1K1
 info@peri.ca
 www.peri.ca



- | | | | | |
|---|---|---|--|--|
| <p>37 Lebanon
PERI Lebanon Sarl
90416 – Jdeideh
lebanon@peri.de</p> | <p>44 Russian Federation
OOO PERI
142407, Noginsk District
moscow@peri.ru
www.peri.ru</p> | <p>51 Turkmenistan
PERI Kalıp ve İskeleleri
Aşgabat
ahmet.kadioglu@peri.com.tr
www.peri.com.tr</p> | <p>57 Saudi Arabia
PERI Saudi Arabia Ltd.
21463 Jeddah
info@peri.com.sa
www.peri.com.sa</p> | <p>64 Nigeria
PERI Nigeria Ltd.
Lagos
info@peri.ng
www.peri.ng</p> |
| <p>38 Lithuania
PERI UAB
02300 Vilnius
info@peri.lt
www.peri.lt</p> | <p>45 South Africa
PERI (Pty) Ltd
7600 Stellenbosch
info@peri.co.za
www.peri.co.za</p> | <p>52 Belorussia
IOOO PERI Belarus
220100 Minsk
info@peri.by
www.peri.by</p> | <p>58 Qatar
PERI Qatar LLC
P.O.Box: 31295 - Doha
info@periqatar.com
www.peri.qa</p> | <p>65 Oman
PERI (L.L.C.)
Muscat
perimct@perime.com
www.perime.com</p> |
| <p>39 Morocco
PERI S.A.U.
Tanger
info@peri.ma
www.peri.ma</p> | <p>46 Ukraine
TOW PERI
07400 Brovary
peri@peri.ua
www.peri.ua</p> | <p>53 Croatia
PERI oplate i skele d.o.o.
10 250 Lučko-Zagreb
info@peri.com.hr
www.peri.com.hr</p> | <p>59 Algeria
Sarl PERI
Kouba 16092, Alger
info@peri.com
www.peri.com</p> | <p>66 Colombia
PERI S.A.S. Colombia
Briceño, Cundinamarca
peri.colombia@peri.com.co
www.peri.com.co</p> |
| <p>40 Israel
PERI Formwork
Engineering Ltd.
Rosh Ha'ayin, 48104
info@peri.co.il
www.peri.co.il</p> | <p>47 Egypt
PERI Branch Office
11341 Nasr City /Cairo
info@peri.com.eg
www.peri.com.eg</p> | <p>54 India
PERI (India) Pvt Ltd
Mumbai – 400064
info@peri.in
www.peri.in</p> | <p>60 Albania
PERI Representative Office
Tirane
info@peri.com.tr
www.peri.com.tr</p> | <p>67 Philippines
PERI-Asia Philippines, INC.
Makati City
info@peri.com.ph
www.peri.com.ph</p> |
| <p>41 Bulgaria
PERI Bulgaria EOOD
1839 Sofia
peri.bulgaria@peri.bg
www.peri.bg</p> | <p>48 Serbia
PERI – Oplate d.o.o.
22310 Šimanovci
office@peri.rs
www.peri.rs</p> | <p>55 Jordan
PERI GmbH - Jordan
11947 Amman
jordan@peri.com
www.peri.com</p> | <p>61 Peru
PERI Peruana S.A.C.
Villa El Salvador, Lima
contacto@peri.com.pe
www.peri.com.pe</p> | <p>68 Hong Kong
PERI (Hong Kong) Limited
Hong Kong SAR, PRC
bob.dover@periasia.com
www.perihk.com</p> |
| <p>42 Iceland
Armar ehf.
220 Hafnarfjörður
armar@armar.is
www.armar.is</p> | <p>49 Mexico
PERI Cimbras y Andamios,
S.A. de C.V.
Estado de México, Huehuetoca
info@peri.com.mx
www.peri.com.mx</p> | <p>56 Kuwait
PERI Kuwait W.L.L.
13011 Kuwait
info@peri.com.kw
www.peri.com.kw</p> | <p>62 Panama
PERI Panama Inc.
0832-00155 Panama City
info@peri.com.pa
www.peri.com.pa</p> | <p>69 Namibia
PERI (Pty.) Ltd.
Windhoek
windhoek@peri.na
www.peri.na</p> |
| <p>43 Kazakhstan
TOO PERI Kazakhstan
050000 Almaty
peri@peri.kz
www.peri.kz</p> | <p>50 Azerbaijan
PERI Representative Office
Baku
peribaku@peri.com.tr
www.peri.com.tr</p> | <p>63 Angola
Pericofragens, Lda.
Luanda
renato.portugal@peri.pt
www.peri.pt</p> | <p>70 Mozambique
PERI (Pty.) Ltd.
Matola
maputo@peri.co.mz
www.peri.co.mz</p> | |

The optimal System for every Project and every Requirement



Wall Formwork



Column Formwork

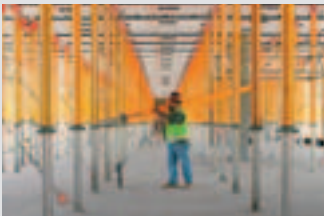

Slab Formwork



Climbing Systems



Tunnel Formwork



Bridge Formwork



Shoring Systems



Construction Scaffold



Facade Scaffold



Industrial Scaffold



Access



Protection Scaffold



System-Independent Accessories



Services



PERI GmbH
Formwork Scaffolding Engineering
 Rudolf-Diesel-Strasse 19
 89264 Weissenhorn
 Germany
 Tel. +49 (0)7309.950-0
 Fax +49 (0)7309.951-0
 info@peri.com
 www.peri.com