

VARIOKIT Cantilevered Parapet Systems

System solutions for new construction and refurbishment projects

Product Brochure – Issue 04/2019

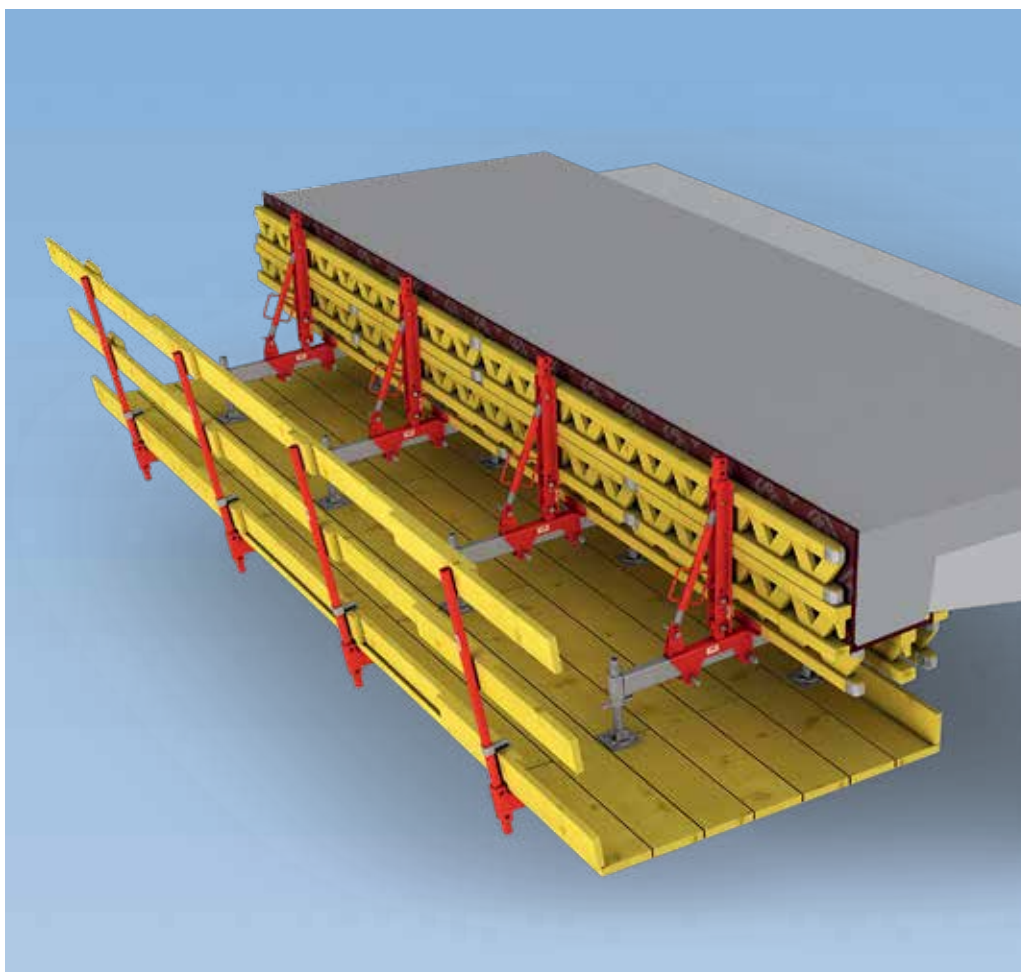

Content

Cantilevered Parapet Systems	
5	VARIOKIT system solutions
VGK Cantilevered Parapet Bracket	
6	VGK system advantages and detailed solutions
8	Anchor solution in detail
10	Project examples
VGB Cantilevered Parapet Track	
14	VGB system advantages and detailed solutions
16	Project examples
VGW Cantilevered Parapet Carriage	
20	VGW system advantages and detailed solutions
22	Project examples

Issue 04/2019

Publisher

PERI GmbH
Formwork Scaffolding Engineering
Rudolf-Diesel-Strasse 19
89264 Weissenhorn
Germany
info@peri.com
www.peri.com

PERI Civil Engineering Solutions

- 24 VARIOKIT system solutions and services from one source
- 26 Applications with the VARIOKIT Engineering Construction Kit
- 28 Individual services for customised bridge and tunnel construction

Important Information

All current safety regulations and guidelines applicable in those countries where our products are used must be observed.

The images shown in this brochure feature construction sites in progress. For this reason, safety and anchor details in particular cannot always be considered conclusive or final. These are subject to the risk assessment carried out by the contractor.

In addition, computer graphics are used which are to be understood as system representations. To ensure a better understanding, these and the detailed illustrations shown have been partially reduced to show certain aspects. The safety

installations which have possibly not been shown in these detailed descriptions must nevertheless still be available. The systems or items shown might not be available in every country.

Safety instructions and load specifications are to be strictly observed at all times. Separate structural calculations are required for any deviations from the standard design data.

The information contained herein is subject to technical changes in the interests of progress. Errors and typographical mistakes reserved.



VARIOKIT system solutions

Cost-effective construction and refurbishment of cantilevered parapets

Depending on the geometry of the parapet, bridge length and type of bridge, different methods are used to construct cantilevered parapets cast in-situ. For this, PERI provides complete system solutions.

Cantilevered parapets - also known as bridge parapets - form the side closure of a bridge. They have no direct static function. Their main task, in addition to protecting the bridge sealing, is guaranteeing a visually attractive lateral closure.

Parapets thus compensate for any building tolerances that have arisen during the construction phase. In addition, they serve as a walkway and for mounting the bridge railings.



VGK Cantilevered Parapet Bracket

The easy-to-handle lightweight for bridges up to 200 m long



VGB Cantilevered Parapet Track

The mobile solution installed below for bridges over 150 m long



VGW Cantilevered Parapet Carriage

The movable, anchorless solution for bridges over 150 m long

VGK system advantages and detailed solutions

The lightweight for new construction and refurbishment projects

For short bridge superstructures up to 200 m long, the VGK Cantilevered Parapet Bracket is a safe, rational and efficient solution in new construction and refurbishment projects.

Lightweight, hand-mounted system components facilitate easy operation and efficient working. The construction with separate platform and formwork unit features penetration-free decking and provides the best possible protection for the on-going flow of traffic below.

The VGK is anchored to the underside of the bridge. As a result, it does not disturb work operations on the upper side of the superstructure at any time.

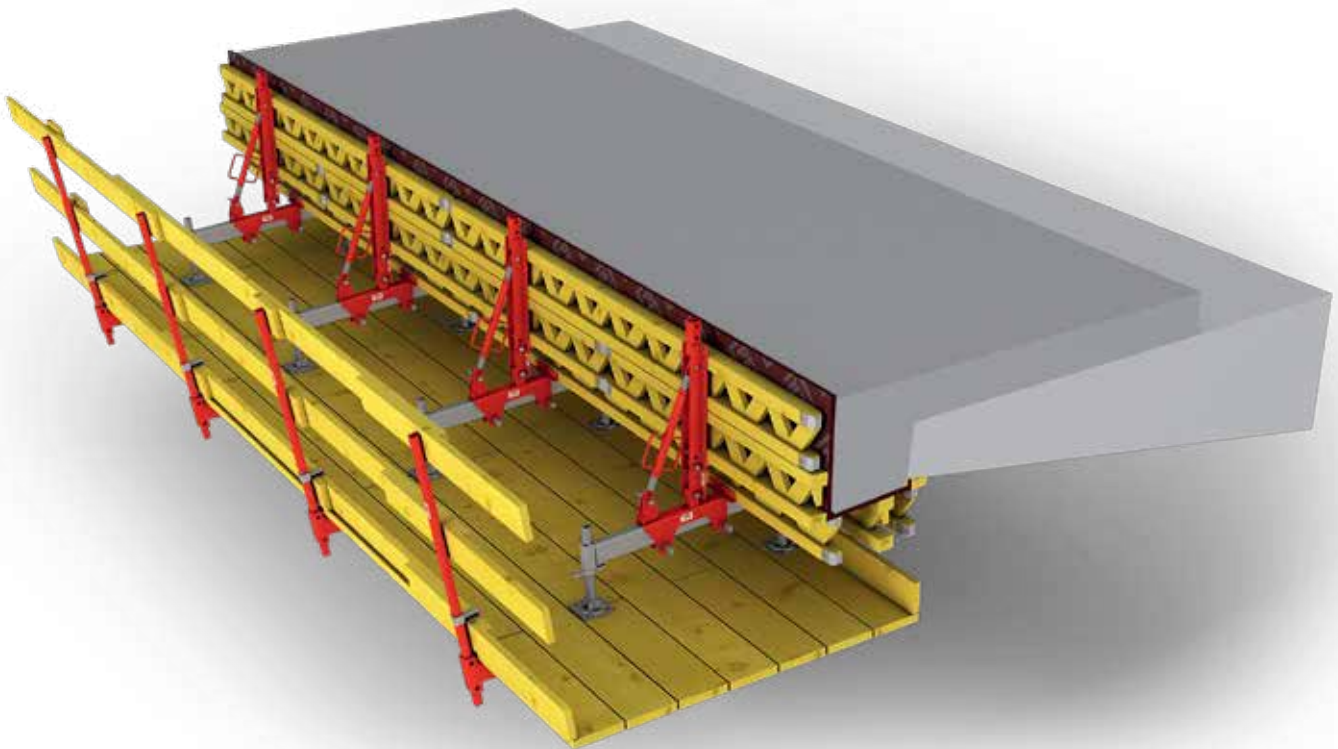

All-round safety

High level of protection for the on-going flow of traffic below due to the penetration-free surface

Efficient working procedures

Thanks to simple, manual assembly and continuous adjustment with a separate formwork unit

Maximum schedule and execution reliability

Thanks to a rentable, type-tested system and suitable anchoring for a wide range of applications

Depending on the structural clearance, parapet geometry and requirements for formworking convenience, different configuration forms are available.

Configuration variants	VGK 80	VGK 120	VGK 150
Type of formwork assembly	Side formwork: Formwork assembly is continuously adjustable Slab formwork: Formwork assembly is carried out by carpenters	Side and slab formwork can be continuously adjusted	
For cantilevered parapet size H (height) x W (width)	60 x 60 cm	60 x 60 cm	100 x 60 cm

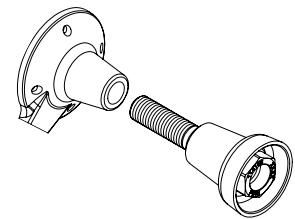
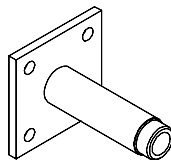
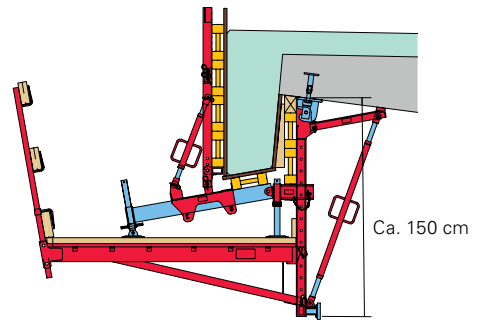
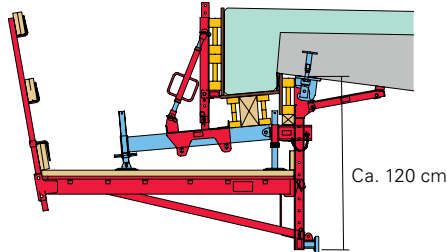
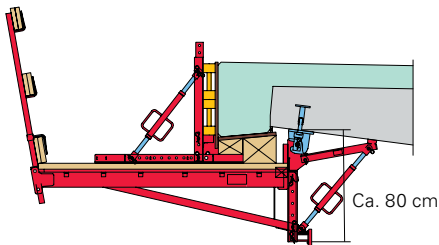

The VGK Cantilevered Parapet Bracket has been designed for a wide variety of application possibilities. The brackets can be mounted to the underside of the cantilever, abutment or retaining walls.

In the area of the bridge cantilever, the PERI Anchor Sleeve M24 is used as standard for anchoring purposes.

For vertical use on the abutment, anchoring is carried out using the PERI Screw-On Cone-2 M24 and Threaded Anchor Plate DW 20.

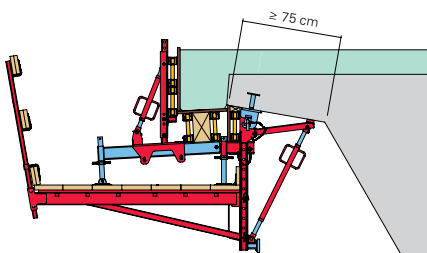

Standard use on a cantilever with a minimum length of 75 cm.

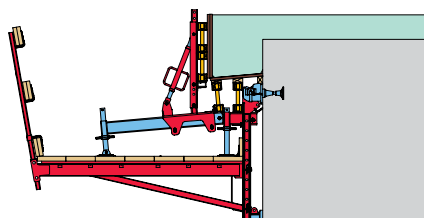

Vertical use of the VGK.

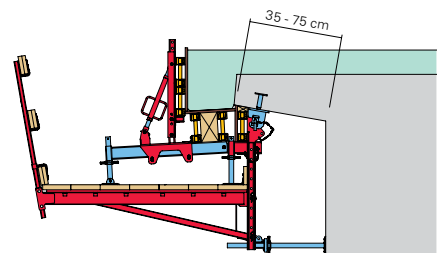

Use in the intermediate area on cantilevers between 35 and 75 cm long.

Anchor solution in detail

The cost-effective solution for parapet refurbishment

The refurbishment anchor is used with the VARIOKIT VGK Cantilevered Parapet Bracket when renovating bridges or retaining walls. The two-piece composite anchor consists of an internal threaded sleeve and an Anchor Bolt. Thereby, the Anchor Bolt can be re-used numerous times and only the sleeve remains as a lost component with the required concrete cover in the bridge cantilever.

The flexible and highly efficient VGK Cantilevered Parapet Bracket was developed especially for refurbishment projects. In connection with the new refurbishment anchor for subsequent installation, this results in a coordinated solution for the respective renovation work. The anchor has General Building Inspectorate Approval.

This closed system solution provides maximum flexibility in planning operations and application, increases planning reliability and work safety as well as ensuring easy assembly. This leads to quality improvements and ultimately to cost savings during execution.

As the refurbishment anchor has a very high load-bearing capacity, only a minimum number of anchor points are required. The anchors are inserted in drilled holes of 22 mm in diameter. Due to its undercut, the refurbishment anchor can be loaded immediately after installation so that the bracket can be mounted directly and without any waiting time. Slipping out during overhead installation is not possible. The full load-bearing capacity of the refurbishment anchor is reached after the composite mortar has hardened. The required embedment depth is ensured by the conical design of the Anchor Bolt and provides maximum assembly safety.

High anchor load-bearing capacity

Large widths of influence and resulting reduced costs for anchoring, assembly and on-site material requirements.

Assembly sequence*



Step 1
Drill hole with $d = 22$ mm and $t = 160$ mm (at right angles to the concrete surface); cleaning the drilled hole with brush and blow-out pump



Step 2
Injecting the composite mortar



Step 3
Screwing in the refurbishment anchor by means of an impact wrench

Immediate assembly of the VGK Cantilevered Parapet Bracket

The undercut allows the Suspension Head and bracket components to be mounted without any waiting time; directly after the composite mortar has hardened, the mounted bracket is also accessible.

Cost-effective realisation of the required concrete cover

The refurbishment anchor provides the required concrete cover for the lost component. No costly stainless steel solutions are necessary.

Reusable Anchor Bolt

The refurbishment anchor consists of two pieces, of which only the internal threaded sleeve is lost. The Anchor Bolt can be unscrewed after use and be re-used many times over.



The Anchor Bolt is re-usable and does not remain in the concrete.



The refurbishment anchor has General Building Authority Approval.



Step 4
Mounting the the Suspension Head VGK with nut M24



Step 5
Fixing the VGK with bolts



After dismantling the bracket
Removing the re-usable Anchor Bolt

* follow the assembly instructions!

Project examples



Cycle Path Bridge, Frankenberg/Saxony, Germany

Simplicity through safety: system combination in bridge construction

The 70-m-long and 4-m-wide cycle path bridge over the Zschopau river was designed as a 3-section reinforced concrete bridge. VARIOKIT Cantilevered Parapet Brackets were used as a safe working platforms to construct the cantilevered parapets, facilitating flexibly adaptable formwork assembly and alignment. All system components are

extremely easy to use and were therefore easy and quick to assemble. Reliable anti-fall protection was realised with PROKIT Side Mesh Barriers. Here, once again, the minimum number of lightweight components simplified assembly operations. And the yellow powder coating made the comprehensive safety measures highly visible from afar.



Bridge over the D6, Čelechovice, Czech Republic

VGK ensured safe working conditions and kept the traffic flowing during bridge refurbishment

On the D6 motorway near Stochov, a 3-section bridge with a length of 77.37 m was completely reconstructed. For this, the bridge sub-structure was rebuilt while the load-bearing prefabricated beams were replaced. All work had to be carried out with traffic still running and any road closures were kept to an absolute minimum. The VGK Cantilevered Parapet Brackets really proved themselves in this project.

In order to keep the duration of road closures during the assembly work as short as possible, the construction team had previously practised the required work steps in the PERI exhibition hall. This considerably accelerated the assembly time on the jobsite.

Well-thought-out planning led to advantages during the execution phase: brackets, platform beams and guardrail posts were already mounted on the prefabricated beams before they were positioned on the new abutment.

As a result, the road only had to be closed very briefly when assembling the platforms. Platform covering and guardrails were easy and quick to install.

After installing the VGK, no additional access was necessary using an elevating work platform or scaffolding from below. The parapet formwork could be mounted from the platforms, while the non-penetrable decking provided protection for the traffic passing below. Further closure of the D6 motorway was not required.

Project examples



Dornbirn Bridge, Bregenz, Austria

On-going rail services: refurbishment work while the trains continue to run below

Cantilevered parapet refurbishment work on a bridge near Dornbirn required safe conditions for construction site personnel, as well as for the trains passing below. Rail traffic closures were minimised thanks to the use of the VGK. The non-penetrable platform covering provided the highest level of protection possible for the area below, thereby allowing train services to be maintained throughout the refurbishment work.

The VGK could be easily and efficiently anchored to the cantilever. The high load-bearing capacity of the bracket facilitated large anchor spacings and thus reduced material and labour costs. The cable duct positioned very close to the cantilever presented no problem during the assembly of the cantilevered parapet bracket. The generous platforms allowed parapet refurbishment without having to dismantle the cable duct.

Once mounted separately on the platform, the formwork could be continuously adjusted by means of a wedge connection. The intuitive system of the wedge connection also accelerated work operations.



Vehicle Bridge, Innsbruck, Austria

Bridge renovation in spite of flowing traffic

In the capital of Tyrol, the cantilevered parapets of a busy road bridge had to be refurbished. The bridge is positioned only a few metres above a large intersection and is crossed by hundreds of road users on a daily basis. For the contractor, it was therefore extremely important to minimise any possible interference with the traffic below.

VARIOKIT Cantilevered Parapet Bracket presented the most cost-effective solution for this project.

The VGK is anchored below on the bridge cantilever, whereby the carriageway on the top of the bridge was not restricted by the bracket, and work could be carried out as normal in this area. Assembly of the VGK bracket is separated

through the working platform and formwork unit. For the cantilevered parapet refurbishment, the working platform was always closed; debris generated during the demolition work could not fall onto the road. This non-penetrable system facilitated the safe execution of the different work operations, such as renovation and concreting, in spite of the enormous volume of traffic.

VGB system advantages and detailed solutions

The mobile solution installed below for bridges over 150 m long

The VARIOKIT Cantilevered Parapet Track is used for the construction and refurbishment of cantilevered parapets at the edge of bridges for over superstructures over 150 m.

Essentially, the VGB consists of core components taken from the VARIOKIT Engineering Construction Kit which are supplemented by functional system components such as the Roller Unit. As a result, the parapet track is characterised by a high degree of flexibility and can be used, for example, on short cantilevers.

The cleverly designed VGB suspension ensures a safe transfer of loads in all conditions; also when concreting, no additional fixings on the superstructure are required. The top of the bridge is freely accessible due to anchoring to the underside of the bridge. As a result, construction site traffic is not affected and work operations can be carried out on and under the bridge during moving traffic.

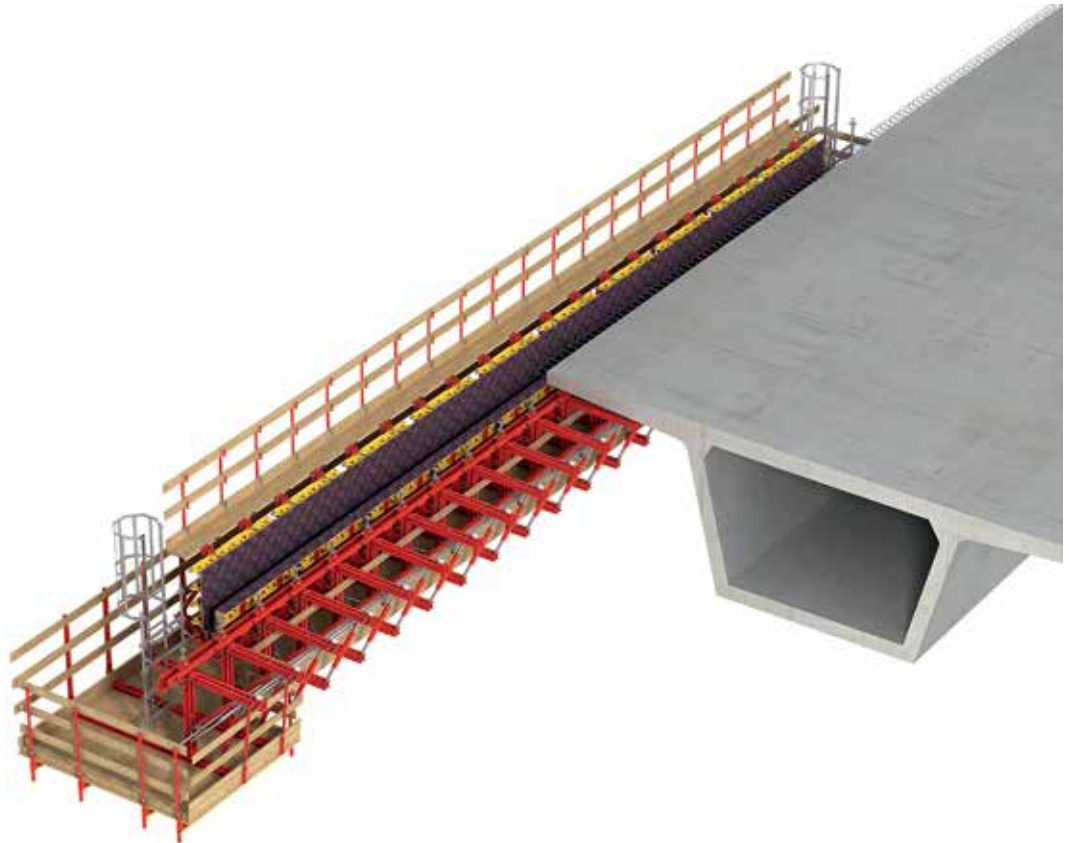

Optimised for your project

Flexibly adaptable system which is based on the VARIOKIT Engineering Construction Kit.

Fast work operations

Additional anchoring is not required because the Roller Unit safely transfers the concreting loads.

Complete system solution

Formwork, pulling and anchor technology from a single source

The striking procedure takes place using only two steps per unit. Firstly, the external formwork is pivoted away by screwing in the SLS Heavy-Duty Spindle. After this, the slab and internal formwork can be struck by moving the Adjusting Unit. The Cantilevered Parapet Track can now be easily moved to the next section.

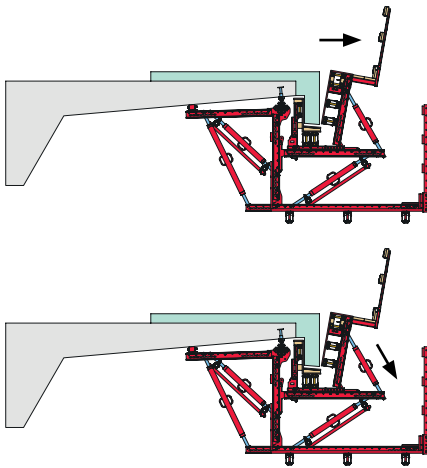

Safe access possibilities to the platforms are provided via the leading and finishing platforms. The recommended moving and concreting length of the Parapet Track is 20 to 25 m.

In accordance with the size of the parapet, anchor spacings of 100, 125 and 150 cm can be realised by combining the 100 and 150 cm rail lengths. This leads to optimal utilisation of the formwork carriage and a reduction in the number of anchor points.

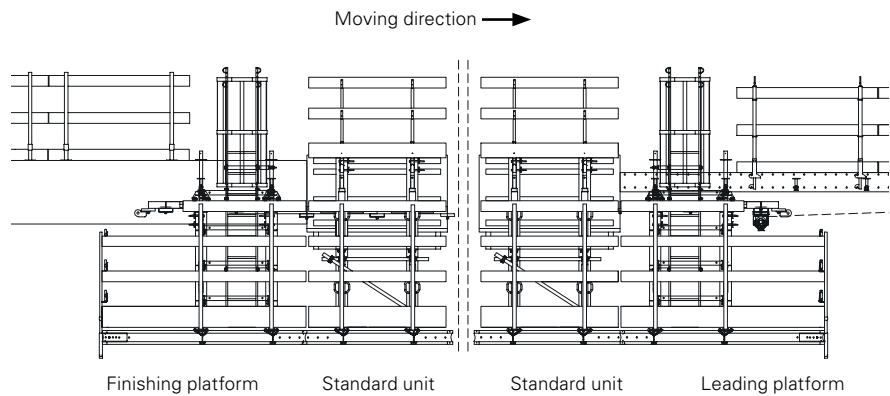
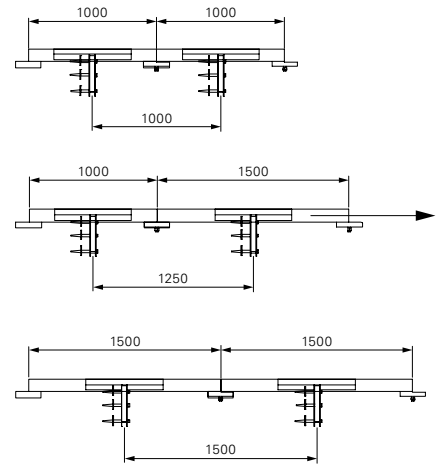

The rollers to be freed up are dismantled from the finishing platform and re-mounted in the moving direction at the front from the leading platform.



The Roller Unit is self-aligning and reliably transfers the concreting loads.



The rail units can be moved by means of hydraulic winches and the RCS Hydraulic Pump.

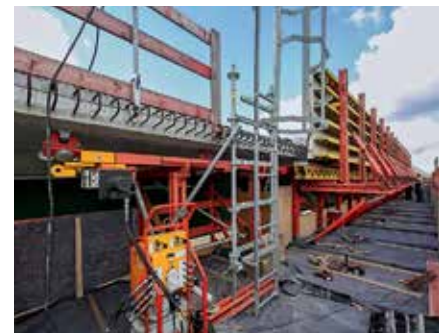

Project examples



Refurbishment of the Inntal Bridge A 12, Radfeld/Tyrol, Austria

All clear: bridge renovation without any jobsite traffic jams

During the renovation and widening work on the 185-m-long Inntal Bridge near Radfeld/Tyrol, road traffic on both carriageways had to remain largely unaffected throughout the project. Therefore, contractor Strabag AG decided in favour of a formwork and scaffolding solution from PERI which was based on two complementary modular construction systems. Due to the rentability of the PERI system components and the easy handling, the refurbishment concept was also very cost-effective.

To refurbish the outer parapets on the north side, two VARIOKIT Cantilevered Parapet Tracks were used. These ran on rollers fixed to the underside of the cantilever. As a result, the superstructure was free of any obstacles, whereas the existing drainage system was removed in several stages, along with demolition of the old parapet, while the new parapet was then shuttered and concreted section by section and new drainage pipes were installed. In addition, the mobile platform served to store and transport

the resulting construction rubble. One of the two Parapet Tracks was previously used on the southern side for refurbishment work on the underside. Competent planning services and the provision of a supervisor were also an essential element of the PERI overall solution. The incomplete as-built documentation required a high degree of flexibility and maximum adaptability – in the planning phase as well as during assembly and use on site.



New Construction of the Ruhrtal Bridge, Bermecke, Germany

Gaining momentum: VGB accelerates concreting of the cantilevered parapets

The Ruhrtal Bridge near Bermecke crosses the Ruhr Valley between Olsberg/Bigge and Nuttlar with a length of 626 m and height of up to 50 m alongside the B 480. The superstructure of the steel composite bridge was constructed using the incremental launching method. With individual spans of 49.95 m – 8 x 65.70 m – 49.95 m, it runs radially over a railway line, as well as over an area of forest and meadows. The composite cross-section consists of an upwardly open, trapezoidal hollow-box girder made of steel as well as

an unstressed concrete carriageway. The joint-venture partners relied on PERI and two VARIOKIT Cantilevered Parapet Tracks for subsequent execution of the cantilevered parapets. The VGB Roller Units were anchored to the underside of the superstructure. By means of suspended rails, the cantilevered parapet track could then be moved using a hydraulically-operated cable winch. No additional anchors had to be fixed to the concrete even during the concreting operations – all loads were safely and reliably transferred by

the Roller Unit. When concreting was finished, the Roller Units could be removed from the finishing platform again. They were then re-anchored in front of the platform – executed from the leading platform – thus allowing the track to be pulled forward by means of a hydraulically-operated cable winch. This system not only resulted in very fast shuttering times and offset cycles but was also characterised by low material costs and work requirements.

Project examples

Immensitz Bridge A81, Geisingen, Germany

Quick and simple: 10-m cantilevered parapet daily

The outer and inner parapets of the Immensitz Bridge were realised with the help of two VARIOKIT Cantilevered Parapet Tracks. Thanks to the simple handling and movability of the PERI system, the construction team was able to complete on average a 10-metre length of parapet every day.

The 227-m-long Immensitz Bridge takes the A 81 motorway between the Geisingen and Engen junctions over the L191 secondary road at a height of 25 m. The bridge superstructure was built in 1971 and needed to be refurbished. The initial phase saw the North Bridge being demolished and a new steel composite construction erected

on the existing bridge piers and abutments. This was followed by realisation of the southern superstructure, during which traffic was guided over the completed new structure until the end of the construction period.

The PERI team planned two Parapet Tracks on the basis of the VARIOKIT Engineering Construction Kit to construct both cantilevered parapets on the southern bridge structure. As a result, parapets of 60 m to 80 m – with section lengths of 20 m respectively – were formed, reinforced and concreted every week. PERI engineers adapted the formwork and platform dimensions according to project specifications to

suit the local conditions, thereby taking into account the different positions of the lateral bracing of the bridge superstructure. In addition, due to the statically optimised arrangement of the anchoring points, the number of mounting parts in the superstructure could be considerably reduced, thus saving costs.

The top of the bridge was freely accessible due to anchoring to the underside of the bridge. As a result, traffic was not affected by the construction site and work could be carried out while traffic was moving on and under the bridge. This created almost unrestricted construction options.



During the bridge construction work, traffic on the A 81 motorway was able to use the already completed superstructure between the Geisingen and Engen junctions.



The VARIOKIT Cantilevered Parapet Track was suspended by means of rails and Roller Units from the underside of the bridge cantilever – at an identical position to the moving procedure and concreting.



The units could be moved quickly thanks to an integrated cable winch.



VGW system advantages and detailed solutions

The movable, anchor-free solution for bridges over 150 m long



Optimised for your project

Flexibly adaptable thanks to VARIOKIT

Rentable

Fast availability in the rental park and low investment costs

Simple and fast assembly

thanks to fitting pin connections and optional pre-assembled units

The PERI Cantilevered Parapet Carriage provides a flexible, efficient and simple solution to meet the requirements of modern bridge construction.

Thanks to the components from the VARIOKIT system, the cantilever of the VGW can be flexibly adapted to suit a wide range of geometries. Frame spacings and formwork lengths per carriage unit can also be designed to be load-dependent. This allows the system to be optimally utilised.

Moving the formwork carriage is carried out cost-effectively and according to project requirements by means of heavy-duty rollers on U-steel profiles. As a rule, no anchoring is required in

the structure and horizontal forces from the concreting operations or wind are transferred by means of friction.

Final assembly is quick and easy through the use of fitting pin connections. As an option, the units can also be delivered pre-assembled.

The VARIOKIT core and system components are all rentable which means they are quickly available and without any prior investment on the construction site.

The few different VARIOKIT core components actually required can be clearly seen here:

- Steel Waler SRU
- Climbing Rail RCS
- Heavy-Duty Spindle SLS
- Accessories such as scaffold tubes and couplers

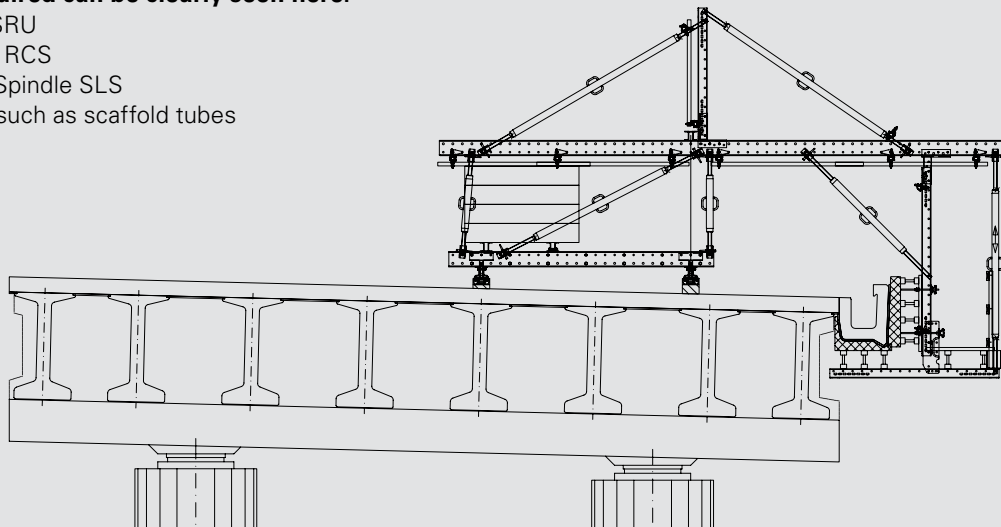

The VGW can be adapted to accommodate a wide range of cantilevered parapet geometries.



The cantilevered parapet carriage being moved on a heavy-duty roller.



The VGW also provides a cost-effective solution for refurbishment projects.



Project examples



Bridge over the Danube near Beška, Serbia

Parapet construction of 130 m per week across the Danube

Parallel to the existing bridge structure, the Danube crossing near Beska has been complemented by a so-called twin bridge. This has facilitated a subsequent, continuous four-lane expansion for the E75 motorway between Belgrade and Novi Sad. A 180-m-long foreland bridge joins the 540-m-long main bridge, which is supported on three river piers. The almost 1,500-m-long approach bridge to the north also crosses a floodplain of the Danube river.

For the bridge over the Danube of almost 2.2 km in length, PERI engineers worked closely with the site management

team to develop a common formwork concept, which envisaged the use of the VARIOKIT Cantilevered Parapet Carriage that was to be operated from above. As a result, no additional mounting components, such as anchor sleeves, were required on the underside. In addition, the standardised assembly system minimised the planning effort – and ensured maximum flexibility of the formwork carriage solution when adapting to local site conditions. Two formwork carriage groups, each with four coupled VARIOKIT Cantilevered Parapet Carriages, worked in parallel.

This meant that six casting segments, each 21.50 m long, could be realised in only five days – 130 linear metres of parapet per week. One of the formwork carriages also took into account the designated points of the parapet widening in order to accommodate the lamp posts. Simple and thereby fast shuttering and striking procedures, as well as the systematic concreting sequence, ensured rapid progress for constructing the parapets with a total length of 4,440 m. In this way, the construction team was able to maintain the extremely tight schedule without any problems.



Franckeplatz Elevated Road Bridge, Halle/Saale, Germany
 Parapet refurbishment with the VGW

The four-lane elevated main road in Halle runs close to the city centre crossing the River Saale and the Glauchaer Platz and Franckeplatz intersections. The bridge refurbishment of the important road link was carried out in two sections: while renovation work was carried out on one of the two parallel bridge structures, traffic on the other bridge was single lane. In order to keep any disruptions to the traffic to a minimum, only 6 months of construction time was available per section for carriageway renewal, parapet refurbishment and modernisation of protective measures – for each 900-m bridge section with its 1,800-m-long parapet. For parapet demolition and forming operations, a total of 12 VARIOKIT Cantilevered Parapet Carriages were used in construction activities at the same time. Two parapet sections, each with 10-m cycle lengths, were concreted on a daily basis. Important components of the PERI solution were planning and static verification as well as the pre-assembly and delivery of ready-to-use formwork and platform elements.

ishment and modernisation of protective measures – for each 900-m bridge section with its 1,800-m-long parapet. For parapet demolition and forming operations, a total of 12 VARIOKIT Cantilevered Parapet Carriages were used in construction activities at the same time. Two parapet sections, each with 10-m cycle lengths, were concreted on a daily basis. Important components of the PERI solution were planning and static verification as well as the pre-assembly and delivery of ready-to-use formwork and platform elements.

VARIOKIT system solutions and services from one source

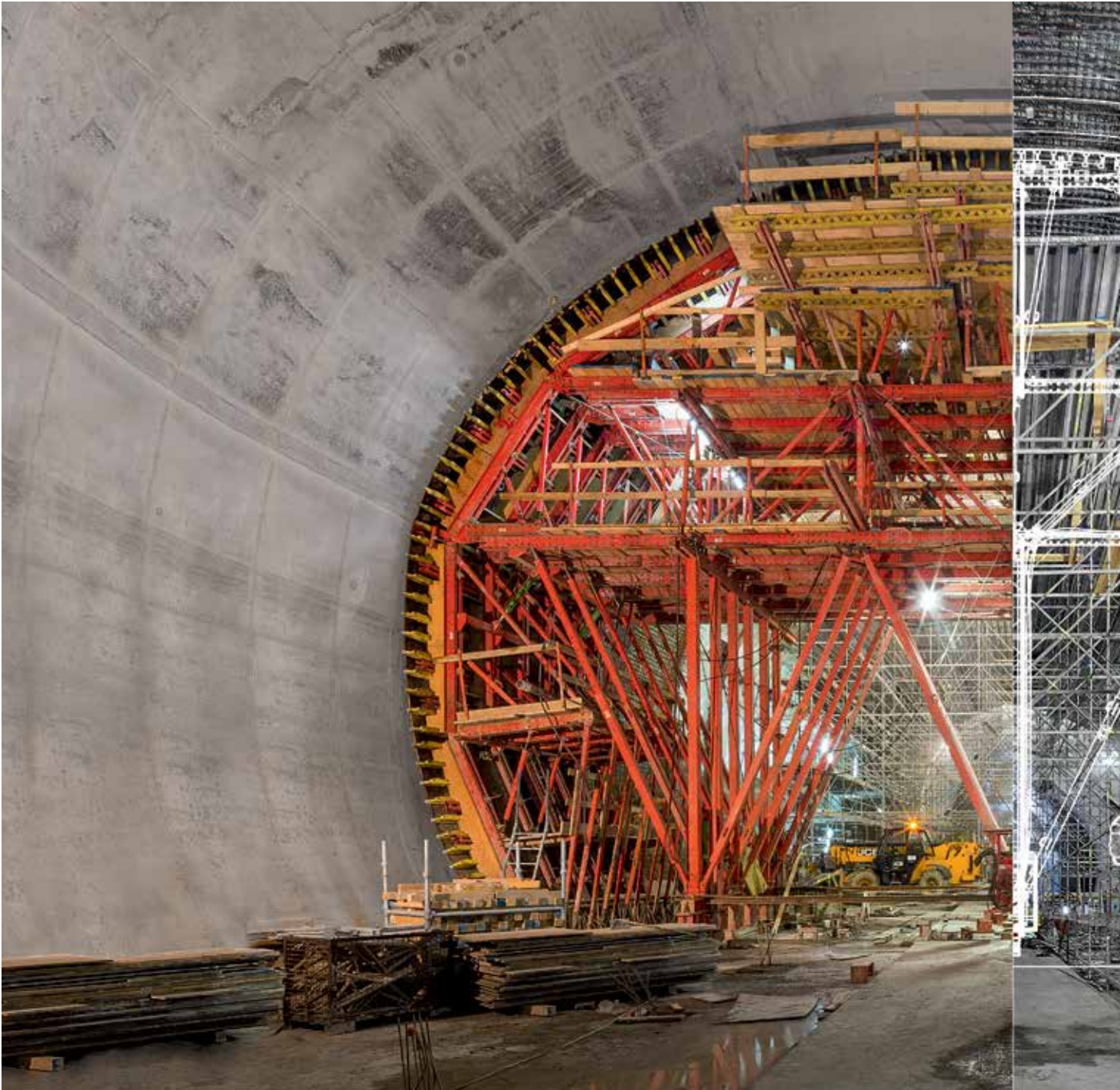

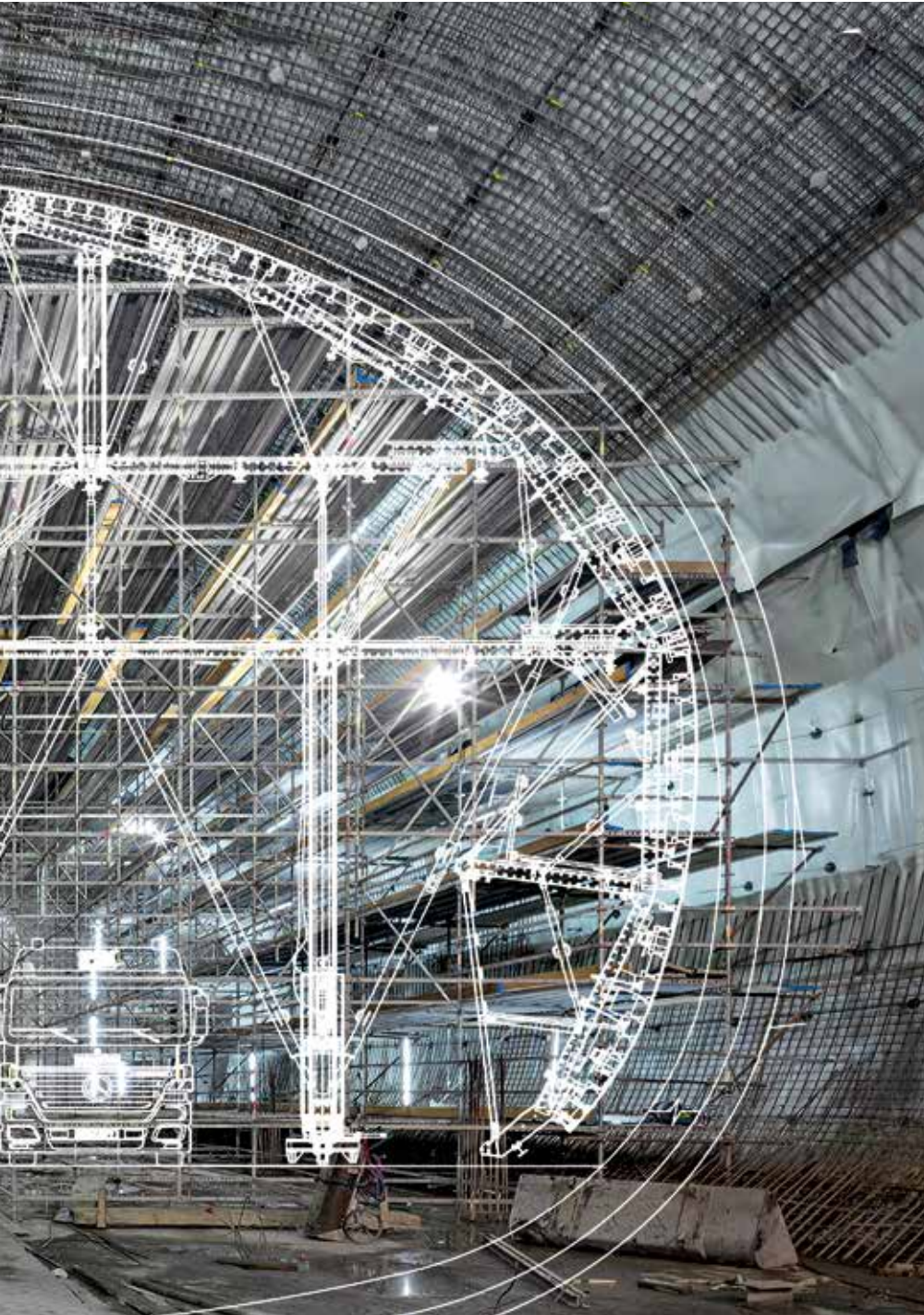

Every bridge and tunnel construction requires project-related planning. With its extensive know-how and expertise, PERI provides not only the required materials but also the complete planning services from a single source.

PERI solutions take into account building and assembly processes along with the maximum functionality for the construction work. With well-engineered technical planning, PERI provides cost-efficient solutions that are optimised on a project-specific basis and are precisely tailored to meet the requirements of the jobsite. Technical project solutions with VARIOKIT and services from one source accelerate the work process enormously.

Applications with the VARIOKIT Engineering Construction Kit

VARIOKIT solutions are typically comprised of around 95 % rentable core and system components. In order to fulfil specific project requirements, only a few special components are needed.

VGB Parapet Track

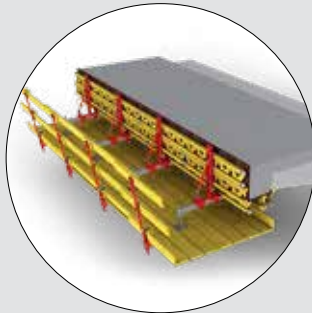
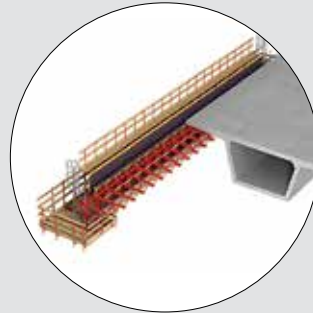

VGK Cantilevered Parapet Bracket



VGW Parapet Carriage



VCB Cantilever Brackets

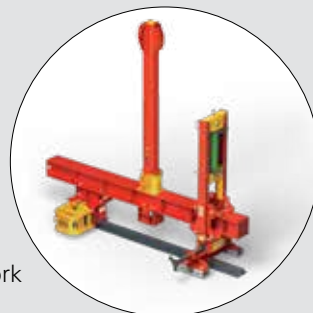

VTC Tunnel Formwork Carriage



VRB Heavy-Duty Truss Girder



VST Heavy-Duty Shoring Tower

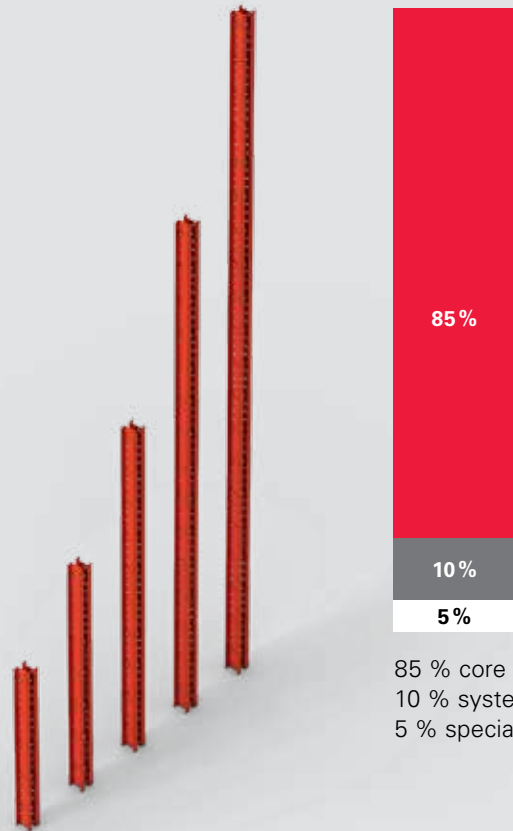

85 % core components
 10 % system components
 5 % special components



VBC Balanced Cantilever Equipment

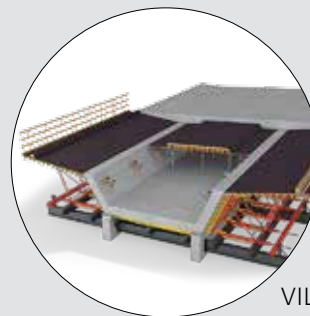

VIL Incremental Launching Facility



VCC Composite Formwork Carriage

Individual services for customised bridge and tunnel construction

In addition to the required materials, PERI also provides a comprehensive range of expertise, as well as the complete planning services from a single source. PERI solutions take into account building and assembly processes along with the maximum functionality for the construction work. For the planning, PERI pays great attention to maximising the utilisation of the rentable core and system components in order to provide customers with particularly cost-effective solutions.

Around 1,300 PERI engineers worldwide plan and design formwork and scaffolding solutions for cost-effective executions. All PERI Engineering planning services are aimed at ensuring that PERI formwork and scaffolding systems in construction operations are always used in line with time, cost and quality standards. The basis for this is the execution plan records which are based either on 2D-views and sections or realistically visualised 3D building models. As a result, technical solutions are developed with customers that optimise the use of materials and the construction process itself.

These planning-related services from PERI Engineering are supplemented by verifiable, static calculations as proof of stability for formwork and scaffolding operations, as well as by project-specific installation and assembly plans for the professional implementation of special applications. Construction site personnel can use the plans to assemble the individual PERI components correctly and prepare them for use.

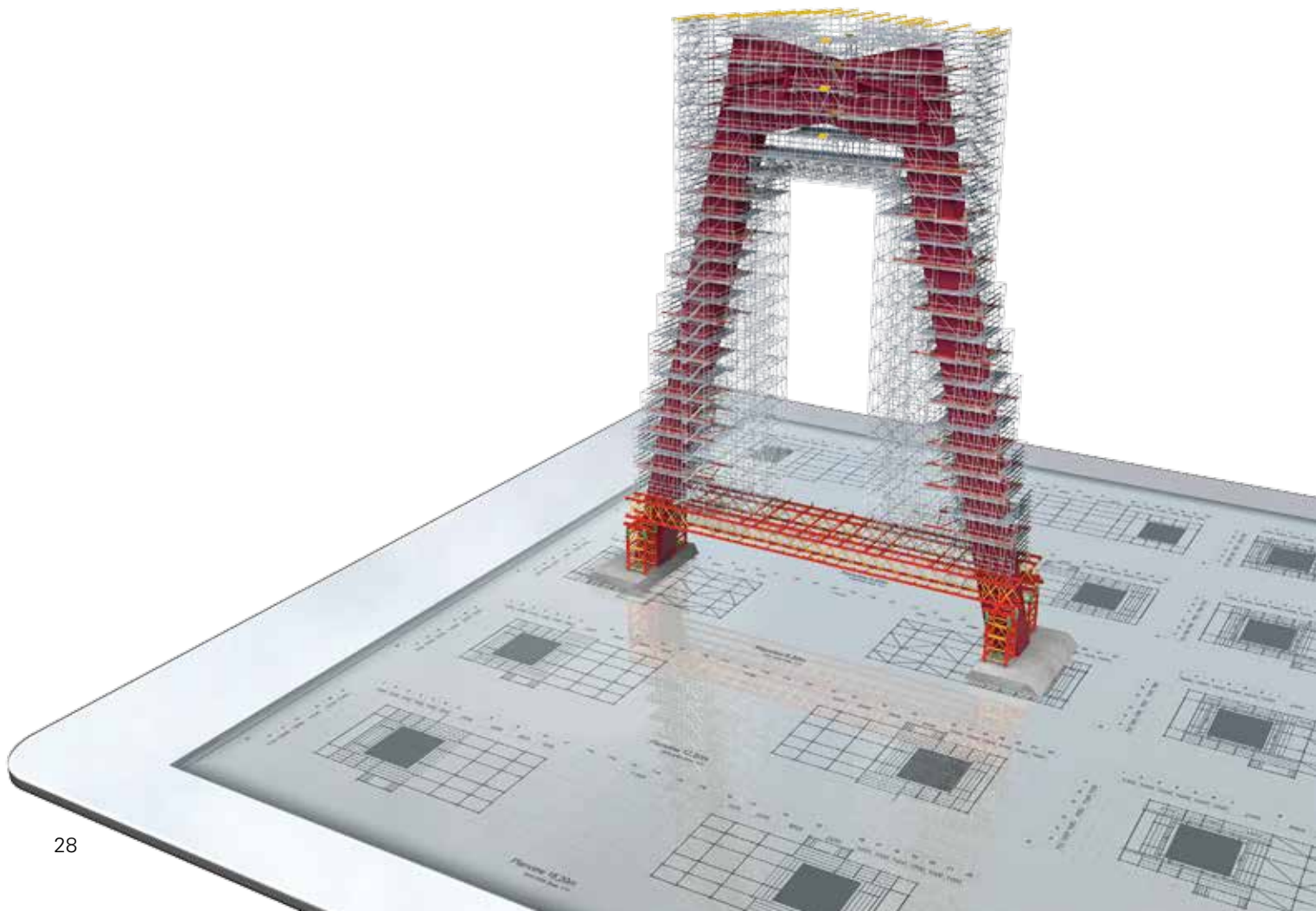



A consistent CAD planning process is realised by bundling the formwork and scaffolding planning.



Implementation plans are coordinated, and it becomes much easier and quicker to organise subsequent plan changes and put them into practice.



PERI supervisors also explain plans and parts lists along with providing information on the maintenance, cleaning and storage of PERI materials. If required, they will provide the construction team with comprehensive on-site support to ensure efficient use of PERI system equipment from the very start.



In order to minimise on-site assembly times and maintain tight construction schedules, PERI also provides – if required – pre-assembled units to the construction site. VARIOKIT is extremely cost-effective, especially with short utilisation times, thanks to the rentable components and assembly advantages.



When it comes to BIM, PERI has been one of the leading companies in the industry for many years now and can already show a number international project references that have been successfully developed with customers using BIM principles.

Through the additional integration of the time and cost factors, the 3-dimensional visualisation of the planning gradually turns into a 4D or 5D model. Additional process data relating to formwork and scaffolding technology, such as required plan changes, automated collision checks, safety checklists and QR codes for object navigation, are documented and tracked in a mobile building information management system. All relevant data is available on the construction site via tablet solutions for day-to-day operations.

PERI International

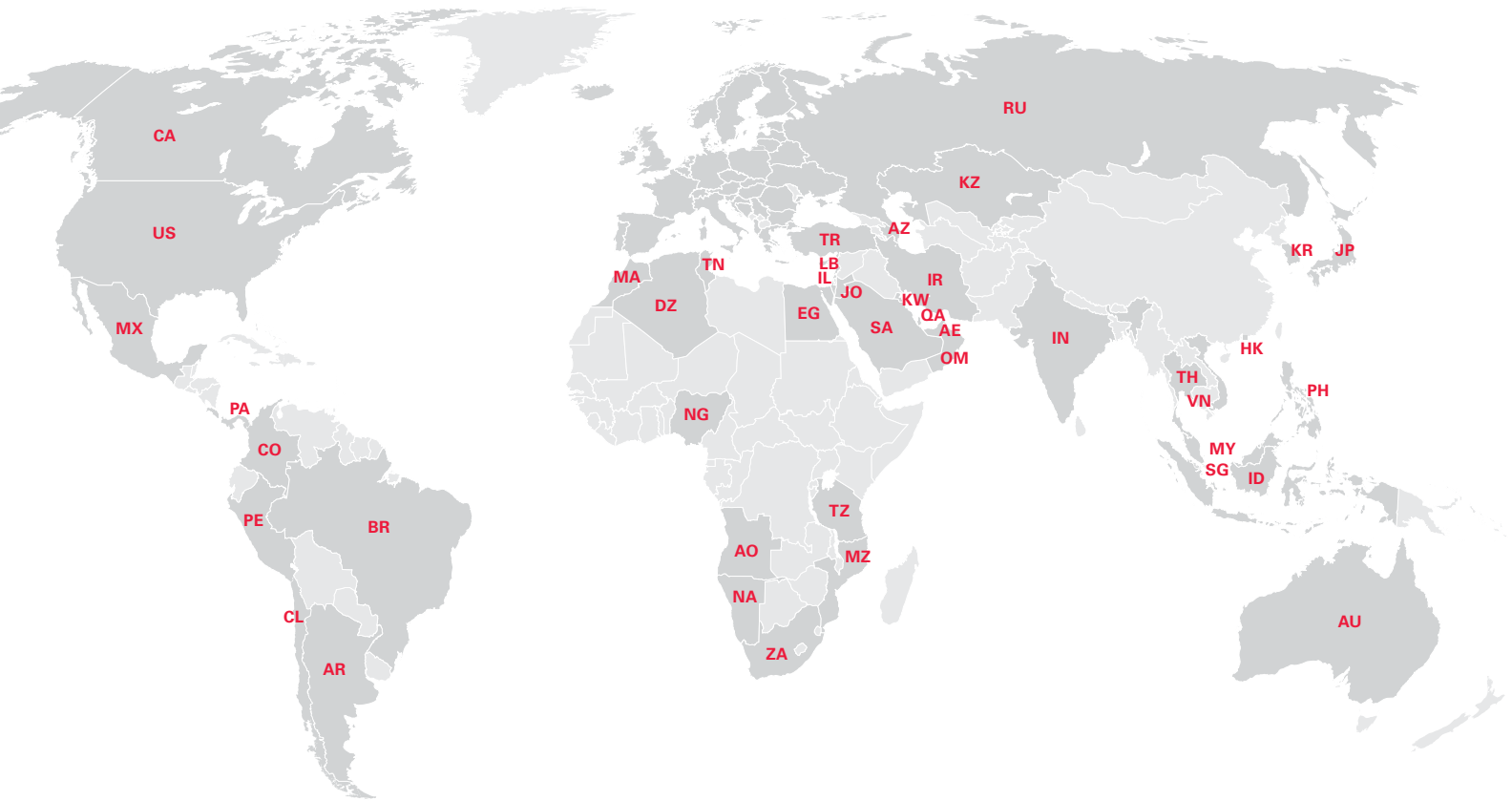

North America

- CA** Canada
PERI Formwork Systems, Inc.
www.peri.ca
- MX** Mexico
PERI Cimbras y Andamios, S.A. de C.V.
www.peri.com.mx
- PA** Panama
PERI Panama Inc.
www.peri.com.pa
- US** USA
PERI Formwork Systems, Inc.
www.peri-usa.com

South America

- AR** Argentina
PERI S.A.
www.peri.com.ar
- BR** Brazil
PERI Formas e Escoramentos Ltda.
www.peribrasil.com.br
- CL** Chile
PERI Chile Ltda.
www.peri.cl
- CO** Colombia
PERI S.A.S.
www.peri.com.co
- PE** Peru
PERI Peruana S.A.C.
www.peri.com.pe

Africa

- AO** Angola
Pericofragens, Lda.
www.peri.pt
- DZ** Algeria
S.A.R.L. PERI
www.peri.dz
- EG** Egypt
Egypt Branch Office
www.peri.com.eg
- MA** Morocco
PERI S.A.
www.peri.ma
- MZ** Mozambique
PERI (Pty.) Ltd.
www.peri.co.mz
- NA** Namibia
PERI (Pty.) Ltd.
www.peri.na
- NG** Nigeria
PERI Nigeria Ltd.
www.peri.ng
- TN** Tunisia
PERI S.A.U.
www.peri.es
- TZ** Tanzania
PERI Formwork and Scaffolding Ltd
www.peri.co.tz
- ZA** South Africa
PERI Formwork Scaffolding (Pty) Ltd
www.peri.co.za

Asia

- AE** United Arab Emirates
PERI (L.L.C.)
www.peri.ae
- AZ** Azerbaijan
PERI Representative Office
www.peri.com.tr
- HK** Hong Kong
PERI (Hong Kong) Limited
www.perihk.com
- ID** Indonesia
PT Beton Perkasa Wijaksana
www.betonperkasa.com
- IL** Israel
PERI F.E. Ltd.
www.peri.co.il
- IN** India
PERI (India) Pvt Ltd
www.peri.in
- IR** Iran
PERI Pars. Ltd.
www.peri.ir
- JO** Jordan
PERI GmbH – Jordan
www.peri.com
- JP** Japan
PERI Japan K.K.
www.peri.co.jp
- KR** Korea
PERI (Korea) Ltd.
www.perikorea.com
- KW** Kuwait
PERI Kuwait W.L.L.
www.peri.com.kw
- KZ** Kazakhstan
TOO PERI Kazakhstan
www.peri.kz
- LB** Lebanon
PERI Lebanon Sarl
lebanon@peri.de
- MY** Malaysia
PERI Formwork Malaysia Sdn. Bhd.
www.perimalaysia.com
- OM** Oman
PERI (L.L.C.)
www.peri.ae
- PH** Philippines
PERI-Asia Philippines, INC.
www.peri.com.ph
- QA** Qatar
PERI Qatar LLC
www.peri.qa
- SA** Saudi Arabia
PERI Saudi Arabia Ltd.
www.peri.com.sa
- SG** Singapore
PERI Asia Pte Ltd
www.periasia.com
- TH** Thailand
Peri (Thailand) Co., Ltd.
www.peri.co.th
- TR** Turkey
PERI Kalıp ve İskeleleri
www.peri.com.tr
- VN** Vietnam
PERI ASIA PTE LTD
www.peri.com.vn



PERI

**PERI GmbH
Formwork Scaffolding Engineering**

Rudolf-Diesel-Strasse 19
89264 Weissenhorn
Germany
Tel. +49 (0)7309.950-0
Fax +49 (0)7309.951-0
info@peri.com
www.peri.com

Oceania

AU Australia
PERI Australia Pty. Ltd.
www.periaus.com.au

DK Denmark
PERI Danmark A/S
www.peri.dk

IT Italy
PERI S.r.l.
www.peri.it

SE Sweden
PERI Sverige AB
www.peri.se

Europe

EE Estonia
PERI AS
www.peri.ee

LT Lithuania
PERI UAB
www.peri.lt

SI Slovenia
PERI oplate i skele d.o.o
www.peri.com.hr

AL Albania
PERI Kalıp ve İskeleleri
www.peri.com.tr

ES Spain
PERI S.A.U.
www.peri.es

LU Luxembourg
N.V. PERI S.A.
www.peri.lu

SK Slovakia
PERI spol. s. r.o.
www.peri.sk

AT Austria
PERI Ges.mBH
www.peri.at

FI Finland
PERI Suomi Ltd. Oy
www.perisuomi.fi

LV Latvia
PERI SIA
www.peri-latvija.lv

UA Ukraine
TOW PERI
www.peri.ua

BA Bosnia and Herzegovina
PERI oplate i skele d.o.o
www.peri.com.hr

FR France
PERI S.A.S.
www.peri.fr

NL Netherlands
PERI b.v.
www.peri.nl

BE Belgium
PERI N.V.
www.peri.be

GB United Kingdom
PERI Ltd.
www.peri.ltd.uk

NO Norway
PERI Norge AS
www.peri.no

BG Bulgaria
PERI Bulgaria EOOD
www.peri.bg

GR Greece
PERI Hellas Ltd.
www.perihellas.gr

PL Poland
PERI Polska Sp. z o.o.
www.peri.com.pl

BY Belorussia
IOOO PERI
www.peri.by

HR Croatia
PERI oplate i skele d.o.o.
www.peri.com.hr

PT Portugal
Pericofragens Lda.
www.peri.pt

CH Switzerland
PERI AG
www.peri.ch

HU Hungary
PERI Kft.
www.peri.hu

RO Romania
PERI România SRL
www.peri.ro

CZ Czech Republic
PERI spol. s r.o.
www.peri.cz

IR Ireland
Siteserv Access & Formwork
www.siteservaccess.ie

RS Serbia
PERI oplate d.o.o.
www.peri.rs

DE Germany
PERI GmbH
www.peri.de

IS Iceland
Armar ehf.
www.armor.is

RU Russia
OOO PERI
www.peri.ru

**The optimal System
for every Project and
every Requirement**



Wall Formwork



Column Formwork



Slab Formwork



Climbing Systems



Bridge Formwork



Tunnel Formwork



Shoring Systems



Construction Scaffold



Facade Scaffold



Industrial Scaffold



Access



Protection Scaffold



Safety Systems



**System-Independent
Accessories**



Services



PERI GmbH
Formwork Scaffolding Engineering
 Rudolf-Diesel-Strasse 19
 89264 Weissenhorn
 Germany
 Tel. +49 (0)7309.950-0
 Fax +49 (0)7309.951-0
 info@peri.com
 www.peri.com

